

LEFT

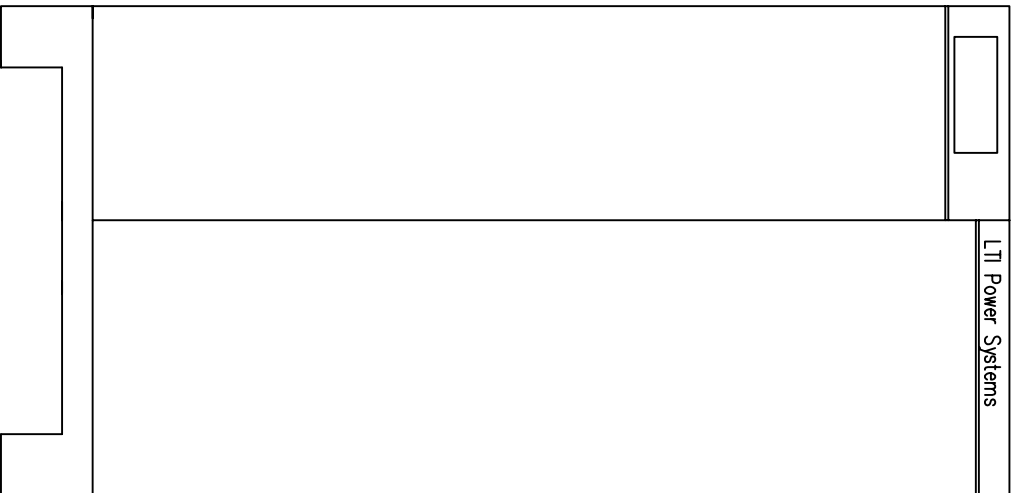

FRONT

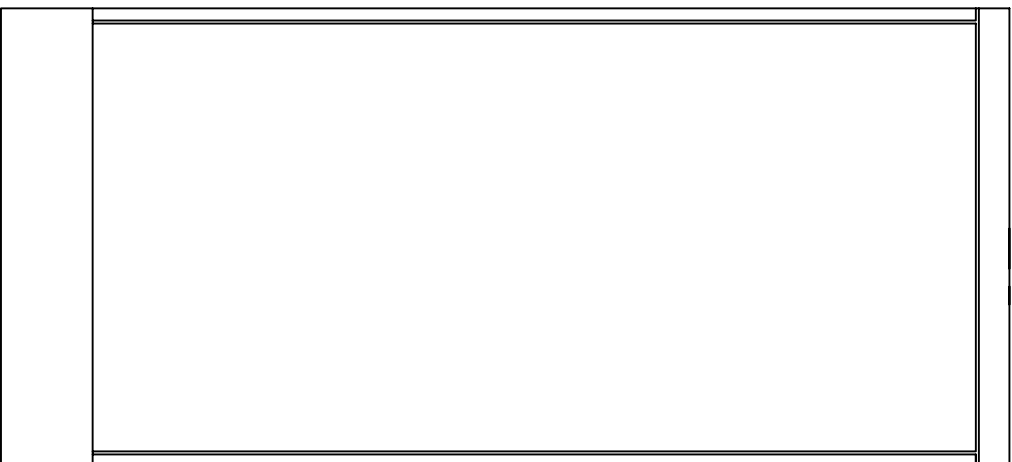

RIGHT

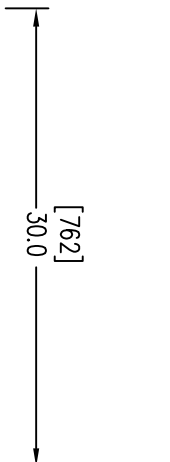
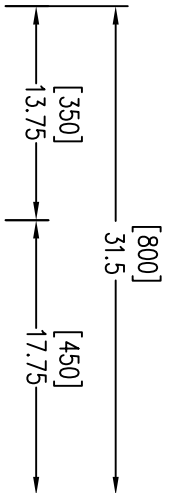

Notes: Unless otherwise specified, dimensions are in inches. Dimensions within brackets [] are in millimeters.
 Recommended clearance for serviceability is 36" [914] on the left side, 18" [457.2] on the right side and 18" [457.2] at the back of the system.

LTI Power Systems, Inc.

TEL. (440) 327-5050

10800 Middle Ave. Elyria, Ohio 44035

ProUPS B800 ENCLOSURE
 10-40KVA

10KVA WEIGHT: 860 LBS. (390 kg)
 15KVA WEIGHT: 950 LBS. (431 kg)
 20KVA WEIGHT: 1058 LBS. (480 kg)
 30KVA WEIGHT: 1150 LBS. (522 kg)
 40KVA WEIGHT: 1220 LBS. (554 kg)

LTI - ProUPS

CAD DWG NAME: RK333-A2

REV.

2

- 1 - ELECTRONICS RACK
- 2 - INVERTER TRF.
- 3 - AC CHOKE
- 4 - AUTODRMR.
- 5 - RECT/STAT. SWITCH POWER PACKS
- 6 - INVERTER POWER PACK
- 7 - MGBS
- 8 - RFI FILTERS

- 9 - TERMINALS
- 10 - BATTERY TERMINALS
- 11 - BATTERY BREAKER
- 12 - INVERTER FUSES
- 13 - BYPASS FUSES
- 14 - pf CORRECTION FUSES
- 15 - RELAY INTERFACE TERMINALS

TERMINATION CONFIGURATION (BOTTOM, FRONT)
 TERMINAL BLOCK CAPACITY: 2/0 TO 14 GA.

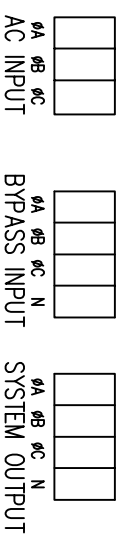

RELAY INTERFACE TERMINATIONS
 TERMINAL CAPACITY: 14 TO 20 AWG.
 RELAYS RATED 1A @ 24VDC, 0.5A @ 120VAC RESISTIVE

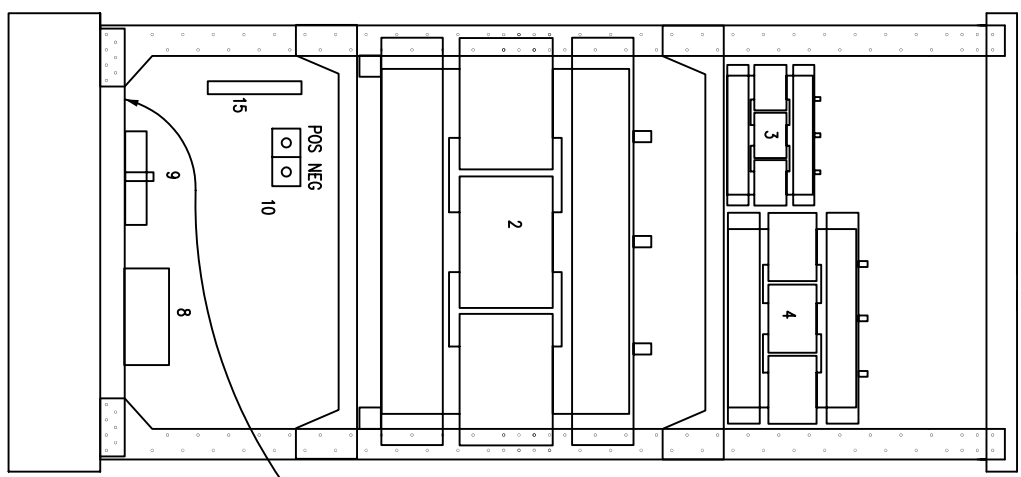
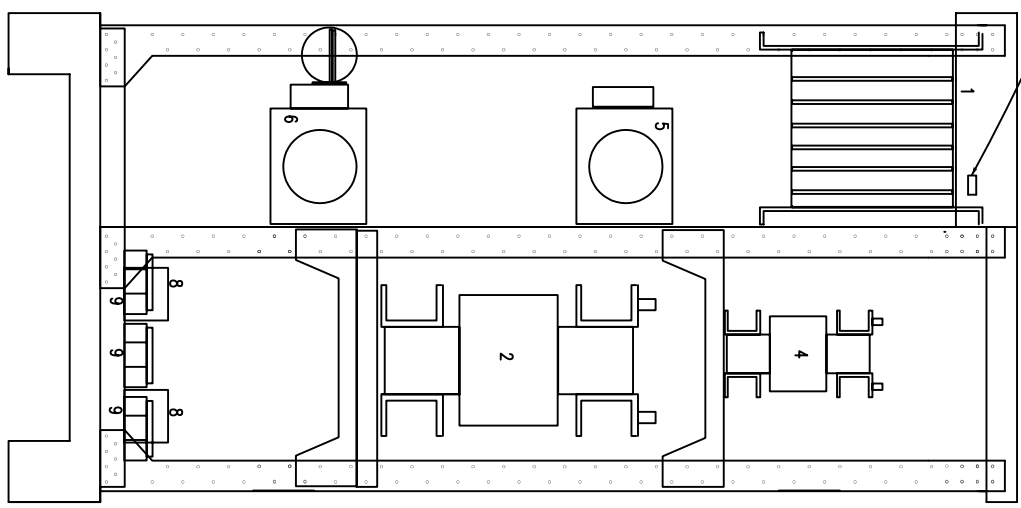
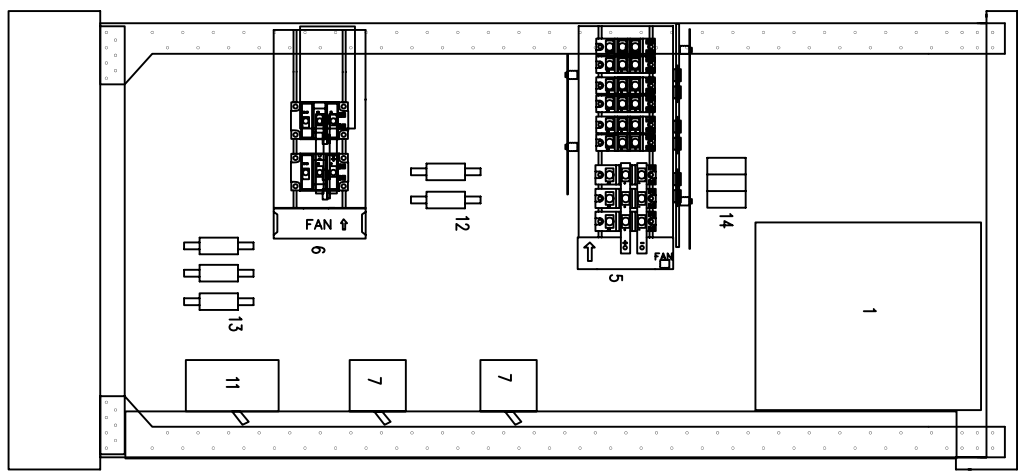
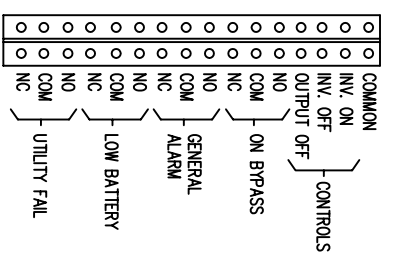

15KVA CONFIGURATION (208/208V)
 3/4" CONDUIT CONDUIT CONDUIT CONDUIT
 (BATTERY) (AC) (BYPASS) (OUTPUT)

15KVA CONFIGURATION (480/208V)
 3/4" 1/2" 3/4" 3/4"
 CONDUIT CONDUIT CONDUIT CONDUIT
 (BATTERY) (AC) (BYPASS) (OUTPUT)

15KVA CONFIGURATION (480/480V)
 3/4" 1/2" 1/2" 1/2"
 CONDUIT CONDUIT CONDUIT CONDUIT
 (BATTERY) (AC) (BYPASS) (OUTPUT)

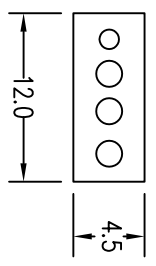

TERMINATION CONFIGURATION (BOTTOM, FRONT)
 TERMINAL BLOCK CAPACITY: 2/0 TO 14 GA.

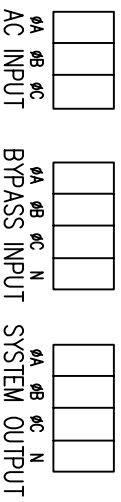

NOTE: ALL DIMENSIONS ARE IN INCHES UNLESS OTHERWISE SPECIFIED.

FRONT

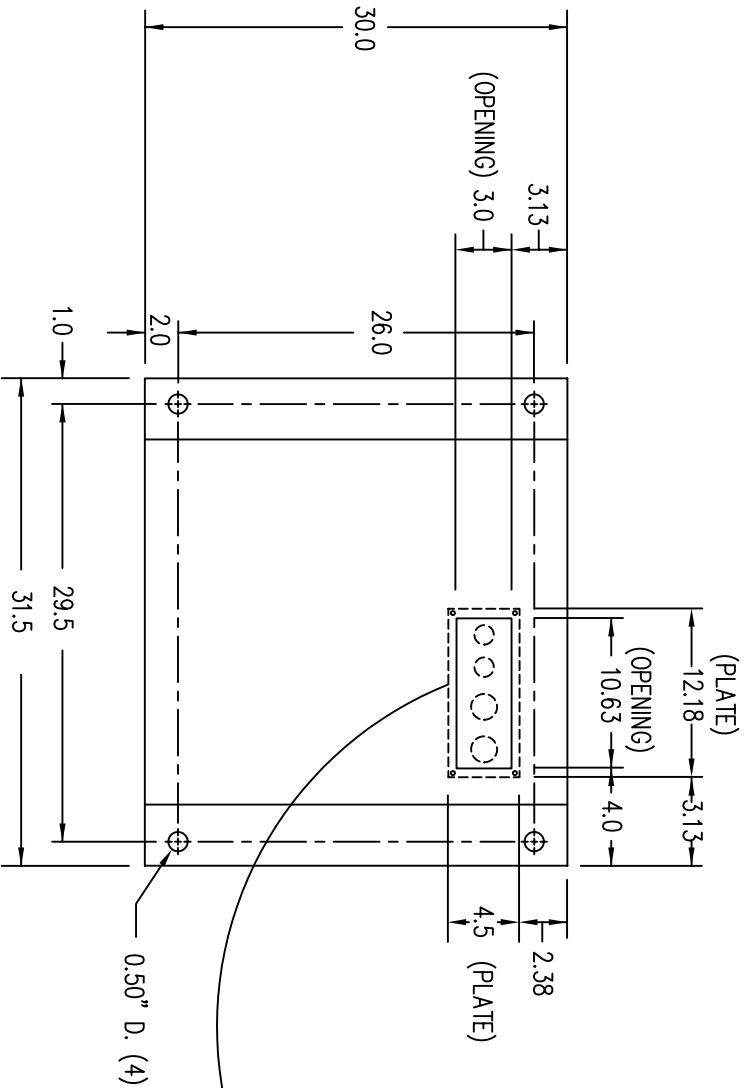

(VIEW FROM BOTTOM OF CABINET)

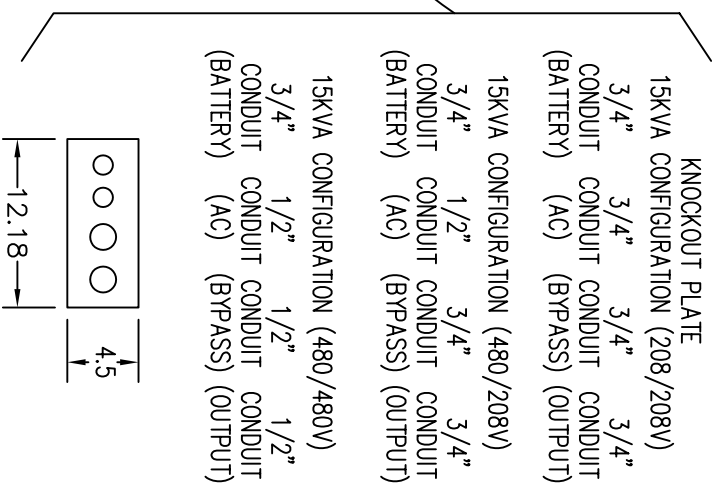

- NOTES:
1. WIRE SIZES BASED ON 90°C COPPER CONDUCTORS OPERATING IN 30°C AMBIENT AND NEC TABLES 250-95 AND 310-16. INCREASE CONDUCTOR SIZE FOR LONG RUNS.
 2. CLOCKWISE PHASE ROTATION MUST BE OBSERVED FOR BYPASS AND AC INPUTS.

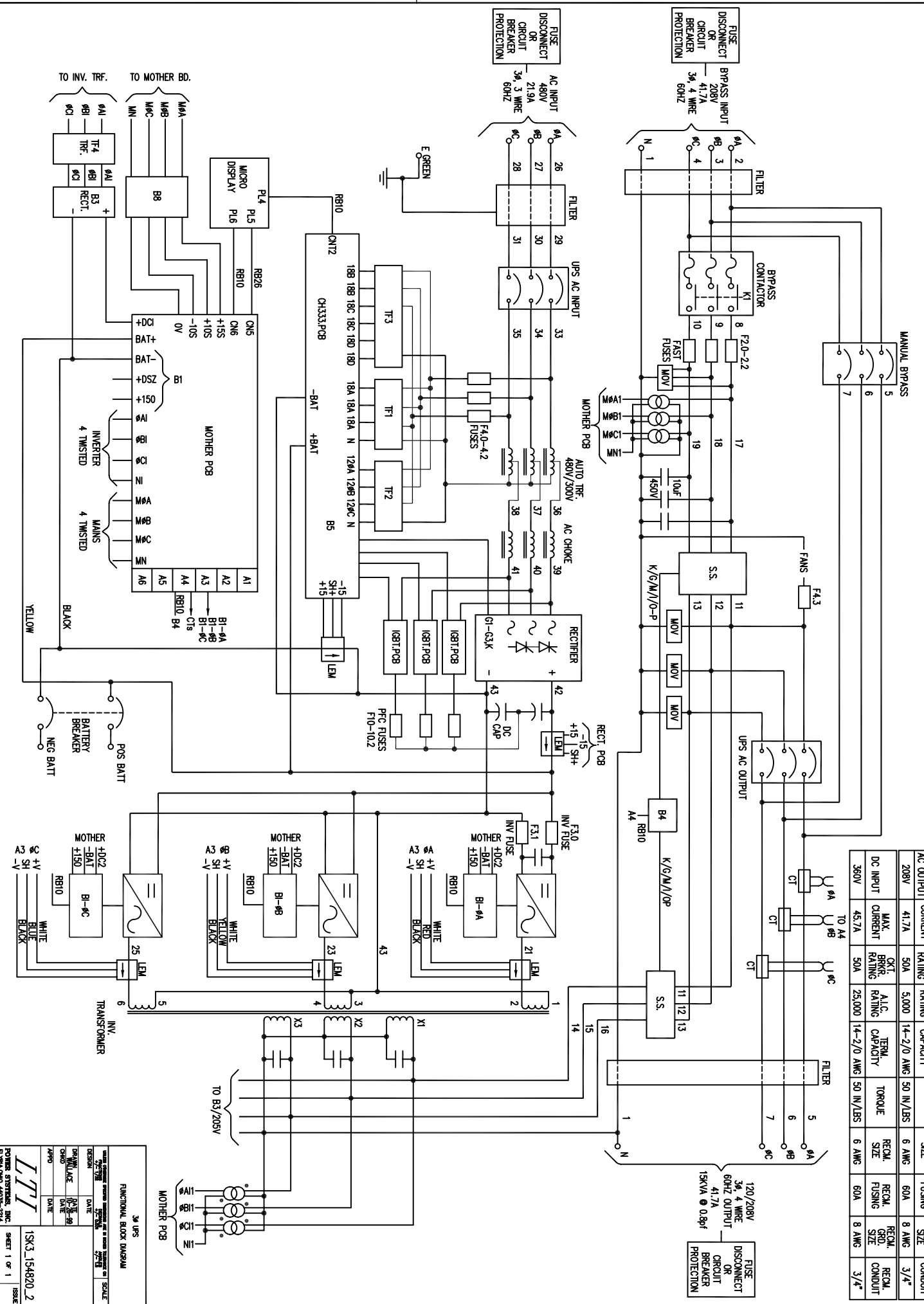

AC INPUT	MAX INPUT CURRENT	CT BRKR RATING	A.I.C. RATING	TERM. CAPACITY	TORQUE	RECM. SIZE	RECM. FLUSING	RECM. GND. CONDUIT
480V	21.9A	30A	25,000	14-2/0 AWG	50 IN/LBS	10 AWG	30A	8 AWG 1/2"
BYPASS INPUT/AC OUTPUT	MAX CURRENT RATING	CT BRKR RATING	A.I.C. RATING	TERM. CAPACITY	TORQUE	RECM. SIZE	RECM. FLUSING	RECM. GND. CONDUIT
208V	41.7A	50A	5,000	14-2/0 AWG	50 IN/LBS	6 AWG	60A	8 AWG 3/4"
DC INPUT	MAX CURRENT	CT BRKR RATING	A.I.C. RATING	TERM. CAPACITY	TORQUE	RECM. SIZE	RECM. FLUSING	RECM. GND. CONDUIT
360V	45.7A	50A	25,000	14-2/0 AWG	50 IN/LBS	6 AWG	60A	8 AWG 3/4"

34 UPS

FUNCTIONAL BLOCK DIAGRAM

DESIGN: [] DATE: []

REV: [] DATE: []

APPD: []

POWER SYSTEMS, INC.
 15K3_154820_2
 SHEET 1 OF 1